

TDA 1

Main Spindle Controller

Project Planning Manual

DOK-DIAX01-TDA*****-PRJ1-EN-P

About this documentation

Contents

Presentation of the modular Main Spindle Controller TDA 1 1

Control cabinet design 2

AS programming module 3

Condition as-delivered 4

Equipment identification 5

Storage and transportation 6

Assembly 7

Installation guidelines 8

Comissioning guidelines 9

Servicing guidelines 10

Index 11

Supplementary documentation 12

Titel TDA 1
Main spindle controller

Type of documentation: Project Planning Manual

Documenttype DOK-DIAX01-TDA*****-PRJ1-EN-E1,44

Internal file reference

- Mappe 7
- TDA1-PJ.pdf
- 209-0042-4112-01

Reference This electronic document is based on the hardcopy document with document desig.: DOK-DIAX01-TDA*****-PRJ1-EN-P • 09.94

This documentation is used:

- to present the controller
- to mechanically integrate the controller into the control cabinet, and offer guidelines on assembly and installation.
- to describe the AS programming module
- to illustrate the equipment delivered and their storage conditions

This documentation provides references to supplementary technical documentation

- for commissioning, operation and servicing
- for electrically integrating the controller, since all standardised electrical connections for main spindle drives are contained in a separate document
- by means of the "Supplementary Overview", listing all technical documentation for main spindle drives and their contents
- by means of the "Supplementary Documentation", listing all titles with their order numbers

Change procedures

Designation of documentation up to present edition	Release-date	Coments
DOK-DIAX01-TDA*****-PRJ1-EN-P	Sep/94	New Edition
DOK-DIAX01-TDA*****-PRJ1-EN-E1,44	Jul./97	First E-Dok

Copyright © INDRAMAT GmbH, 1994
Copying of this document, and giving it to others and the use or communication of the contents thereof, are forbidden without express authority. Offenders are liable to the payment of damages.
All rights are reserved in the event of the grant of a patent or the registration of a utility model or design. (DIN 34-1)

The electronic documentation (E-doc) may be copied as often as needed if such are to be used by the consumer for the purpose intended.

Validity All rights reserved with respect to the content of this documentation and the availability of the products.

Publisher INDRAMAT GmbH • Bgm.-Dr.-Nebel-Straße 2 • D-97816 Lohr
Telefon 0 93 52 / 40-0 • Tx 689421 • Fax 0 93 52 / 40-48 85

Dept ENA (MR, FS)

Table of Contents	Page
1. Presentation of the modular main spindle controller TDA 1	9
2. Control cabinet design	14
2.1. Operating conditions	14
2.2. Mechanical data	16
2.3. Thermal data	19
2.4. Electrical data	22
2.5. Overview of technical data	29
2.6. Type codes	30
3. Programming Module AS	31
3.1. AS programming module versions	32
3.2. AS programming module compatibility	32
3.3. Rating plate	33
3.4. Type codes	34
4. Condition as delivered	35
5. Equipment identification	36
6. Storage and transportation	38
7. Assembly	39
8. Installation notes	41
9. Commissioning guidelines	42
10. Servicing notes	43
10.1. Fault diagnosis	43
10.2. Unit replacement	43
11. Index	45
12. Summary of supplementary documentation	48

1. Presentation of the modular main spindle controller TDA 1



Fig. 2: Modular main spindle controller TDA 1

The main spindle controller TDA 1 is dedicated to the intelligent digital control of INDRAMAT asynchronous main spindle motors 2AD and frameless spindle motors 1MB with a continuous power rating of 3 to 10 kW at the motor shaft.

Main Spindle Drive

Drives equipped with the controller TDA 1 are distinguished by their high stiffness and a wide speed range at constant power. They are, therefore, particularly suited for use as a main spindle drive on numerically controlled machine tool centres.

Spindle positioning

Besides its wide speed range, an a.c. main spindle drive with TDA 1 has an integral position control circuit capable of automatically positioning the spindle (e.g., for workpiece change) with a maximum resolution of 1/4 000 000 revolutions in response to a signal. The internal controller position loop is closed either by the motor feedback signal (for direct drive or gear ratio 1:1) or by an additional, optional spindle feedback signal (switchable gear, belt-driven gears).

Controller for modular drive package

The TDA 1 operates in conjunction with other controllers for feed axes. A combination of power supply module, modular main spindle and servo drive controllers permits individual matching of the drive to the task of a CNC machine tool.

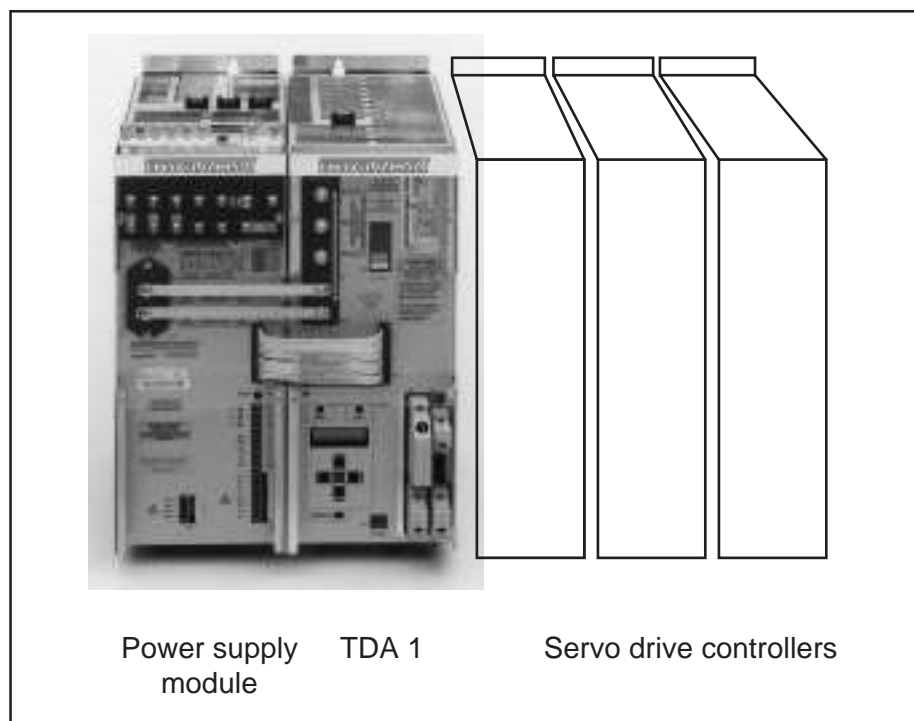

Fig. 3: Drive package with modular main spindle controller TDA 1

C-axis mode

The a.c. main spindle drive with TDA 1 is also capable of operating the spindle as a servo axis (C-axis) with a high-accuracy position control loop. The main spindle motor is fitted with a high-resolution motor feedback device to cope with the low speeds required in this application. The controller detects the rotor position with a maximum resolution of 1/2 000 000 revolutions, thus allowing even the lowest speeds to be precisely controlled.

Incremental encoder output

Since the spindle operates as an interpolating axis in C-axis mode and the NC controls require information on the spindle position, the TDA 1 supplies compatible position signals for incremental encoders through an optional output. The increments are derived either from the high-resolution motor feedback device or from an additional, optional spindle feedback device. The spindle feedback, in the latter case, is a high-resolution main spindle position encoder from INDRAMAT. It is mounted directly onto the spindle. The definition of the incremental encoder output is selectable and provides a maximum resolution of 360 000 increments/revolution in C-axis mode.

1. Presentation of the modular main spindle controller TDA 1

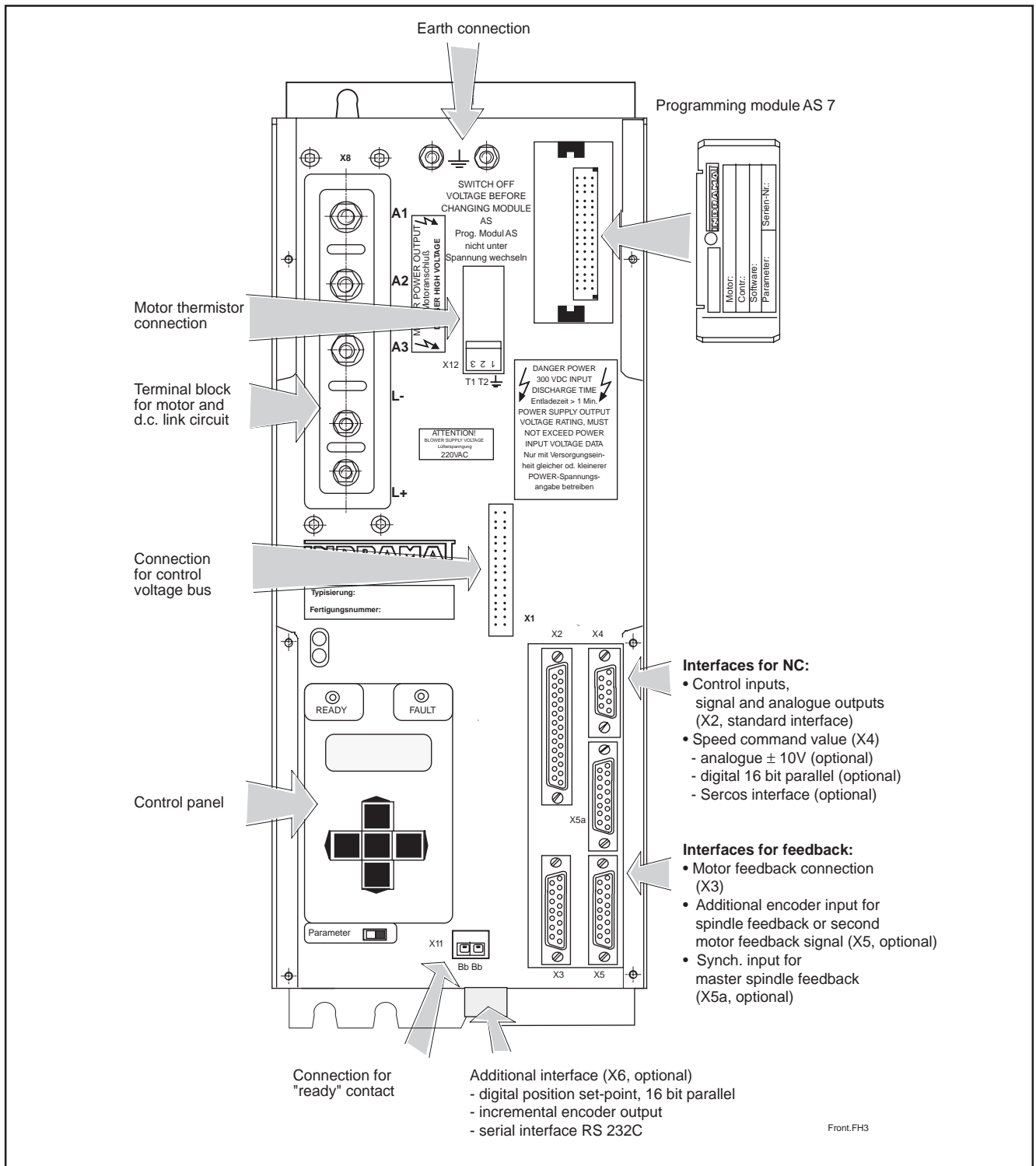

Fig. 4: Designation of TDA 1 features

Parameters

The controller TDA 1 has been designed to operate with parameters. Parameter values are used to match the controller to the main spindle motor, the machine conditions and the requirements of the application.

Programming module	<p>The various parameters relating to both the machine and the application are entered on site during commissioning using the keypad on the control panel. Together with the parameter values for motor matching, these parameter values are stored in the controller's plug-in programming module.</p> <p>In the event of a fault requiring unit replacement, only the controller itself is replaced, the programming module being transferred to the new controller. The characteristics of the drive are stored in the programming module and are therefore immediately available on re-start.</p>
Interface options	
Speed command value	<p>The controllers can be supplied with a variety of speed command interfaces:</p> <ul style="list-style-type: none"> • Analogue speed command ± 10 V for connection to commercially available NC controllers, • Digital speed command 16 bit parallel for connection to PLCs, useful in the case of long cables and small command values, • SERCOS interface for real time communication with the NC controller relating to command and actual value of speed, position and torque, including parameter handling.
Additional encoder input, synchronisation input	<p>An additional encoder input is available for connection of a spindle feedback signal to the controller's internal position loop. For spindle synchronisation, both the additional encoder input and a synchronous input (connection for master spindle feedback signal) are supplied.</p>
Additional interface	<p>The controller TDA 1 also comprises an additional interface, available as:</p> <ul style="list-style-type: none"> • Incremental encoder output for position control by the NC controller in C-axis mode or for thread cutting, • Serial interface for saving and loading parameter values using a PC, • Input for digital position command 16 bit parallel, for 3600 positions selectable by PLC.

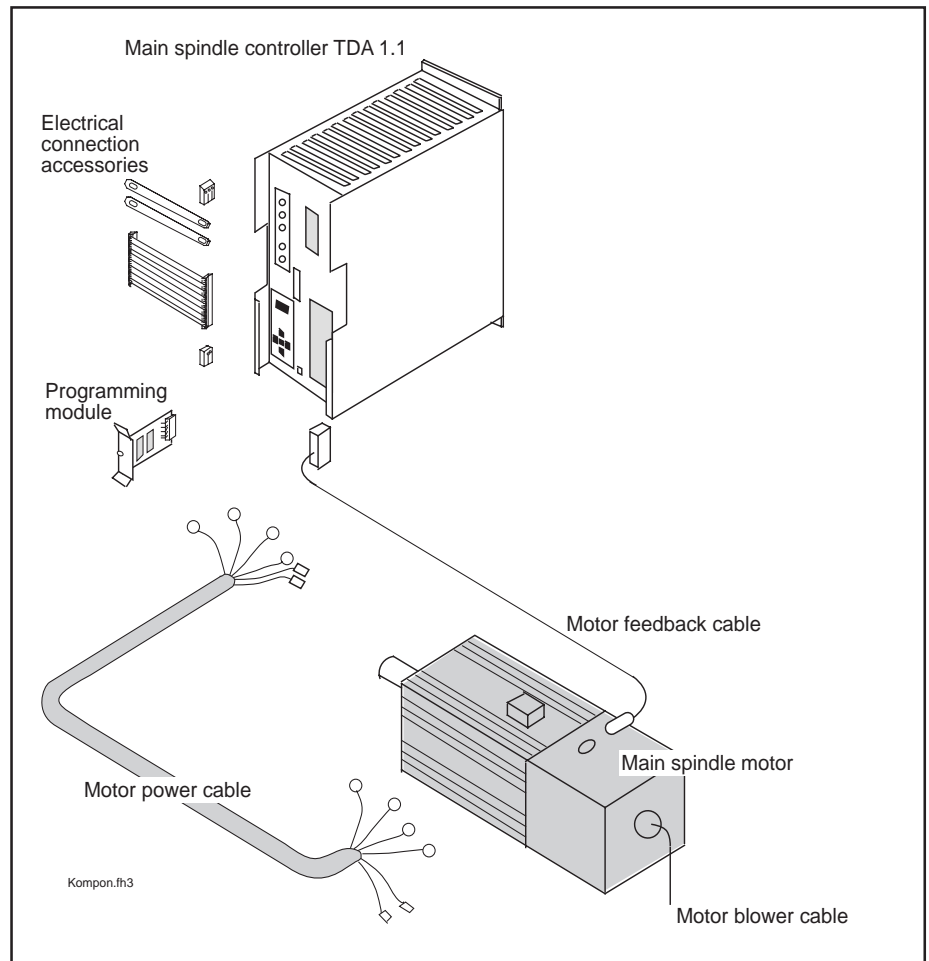

Fig. 5: Components of a modular main spindle drive with their designations

2. Control cabinet design

Information on integrating the main spindle controller TDA 1 into the design is structured according to

- operating conditions
- mechanical data
- thermal data
- electrical data
- technical data/type code

2.1. Operating conditions

Ambient temperature

The values given in the selection data for main spindle drives are unconditionally valid when the controller is operated within an ambient temperature range of +5 to +45°C. The maximum permissible ambient temperature is +55°C, at which the given values for torque and power ratings will be limited according to the graph shown in Fig. 6.

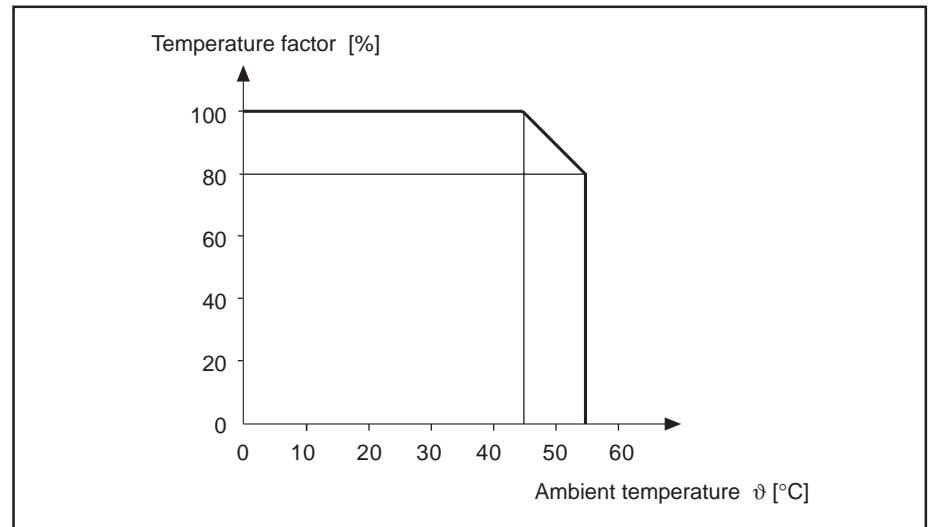

Fig. 6: Temperature-related limitation of drive ratings

Altitude

The maximum operating altitude is 1000 meters above sea level. At higher elevations, the values given in the main spindle drive selection data for torque power ratings will be limited according to the chart in Fig. 7.

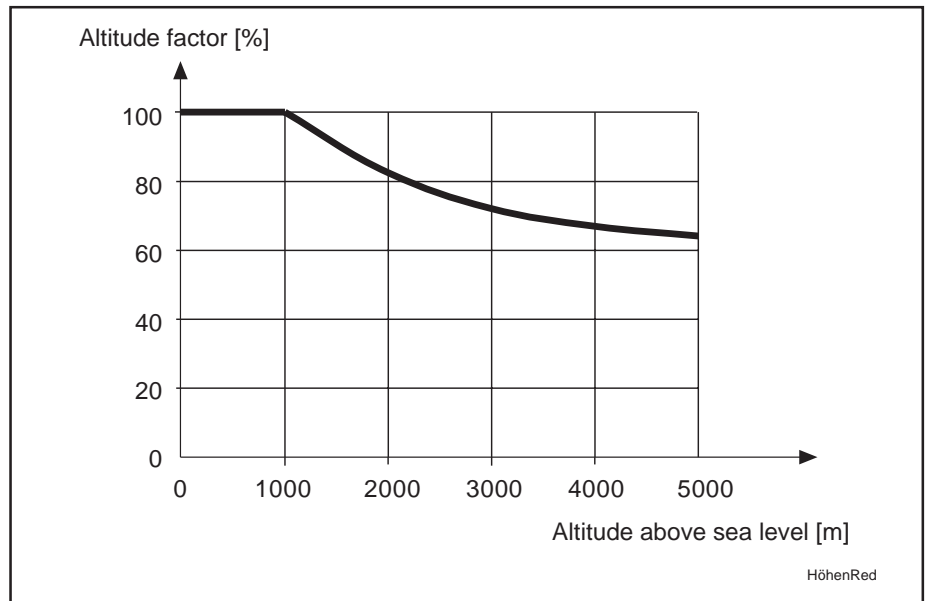

Fig. 7: Altitude-related limitation of drive ratings

Permissible relative humidity of air

The maximum permissible relative humidity of air corresponds to Humidity Class F according to DIN 40 040.

This means that the controller may be operated in locations subject to humidity, such as workshops in cold, temperate and hot, dry climate zones. The mean relative humidity of air may not exceed 70% in the wettest month! Moisture must never be allowed to condense on the unit!

For more details, see DIN 40 040!

Electrical protection

Electrical protection is IP 10 according to DIN 40 050.

This means that the controller is protected against the ingress of solid foreign particles with a diameter of more than 50 mm.

The controller is not protected against

- the ingress of water, or
- intentional contact, e.g. by hand, but does prevent contact of large body surfaces.

For more details, see DIN 40 050!

The TDA 1 has been designed for installation in a control cabinet or a closed housing in conformity with DIN VDE 01 160, sections 5.5.1.3 and 6.5.1.3. Adequate protection against unintentional contact must be provided by the manufacturer of the cabinet according to the valid safety specifications for the respective application. (For industrial equipment, e.g., EN 60204 / DIN VDE 0113, part 1.)

2.2. Mechanical data

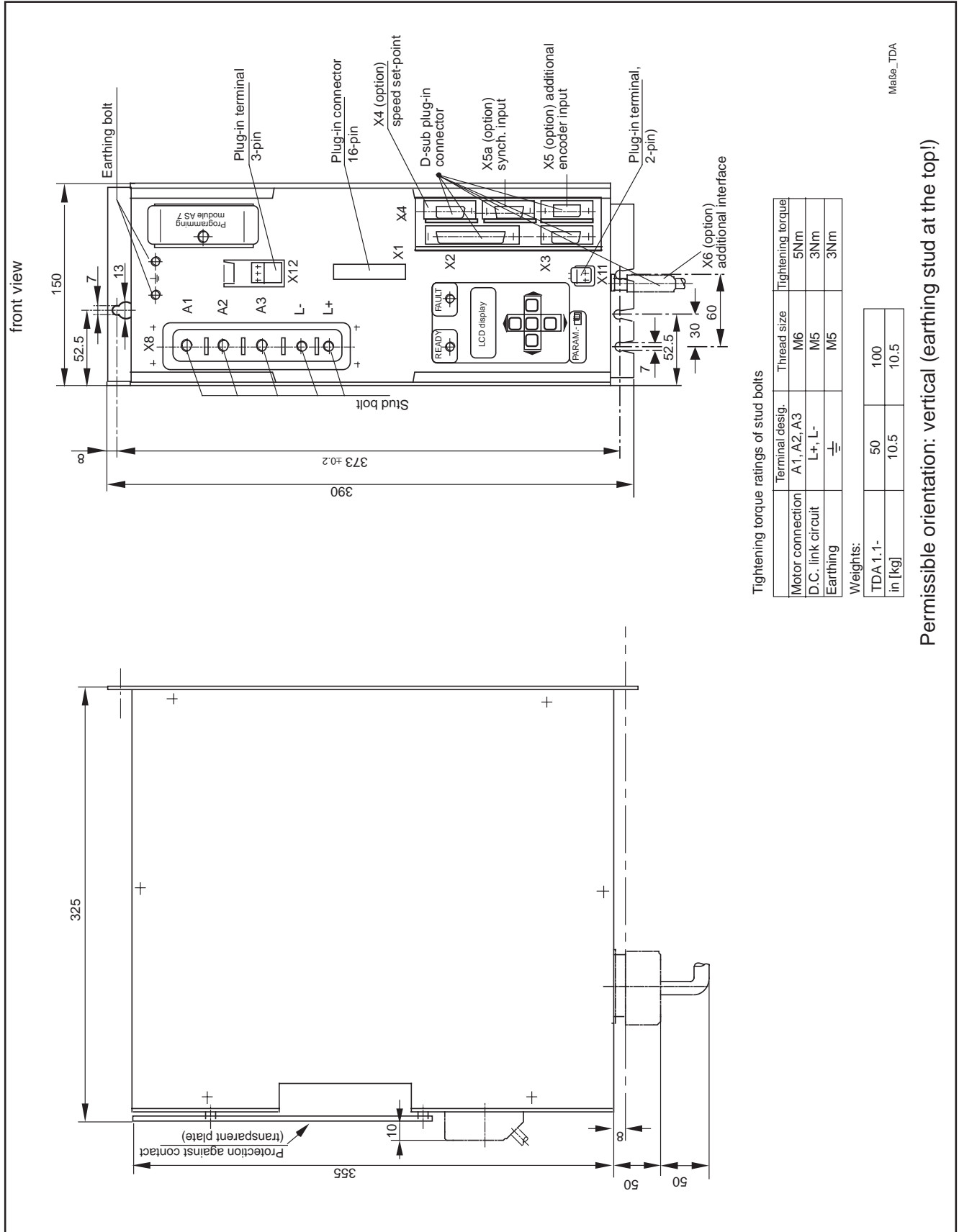

Fig. 8: Dimensional specification of main spindle controller TDA 1

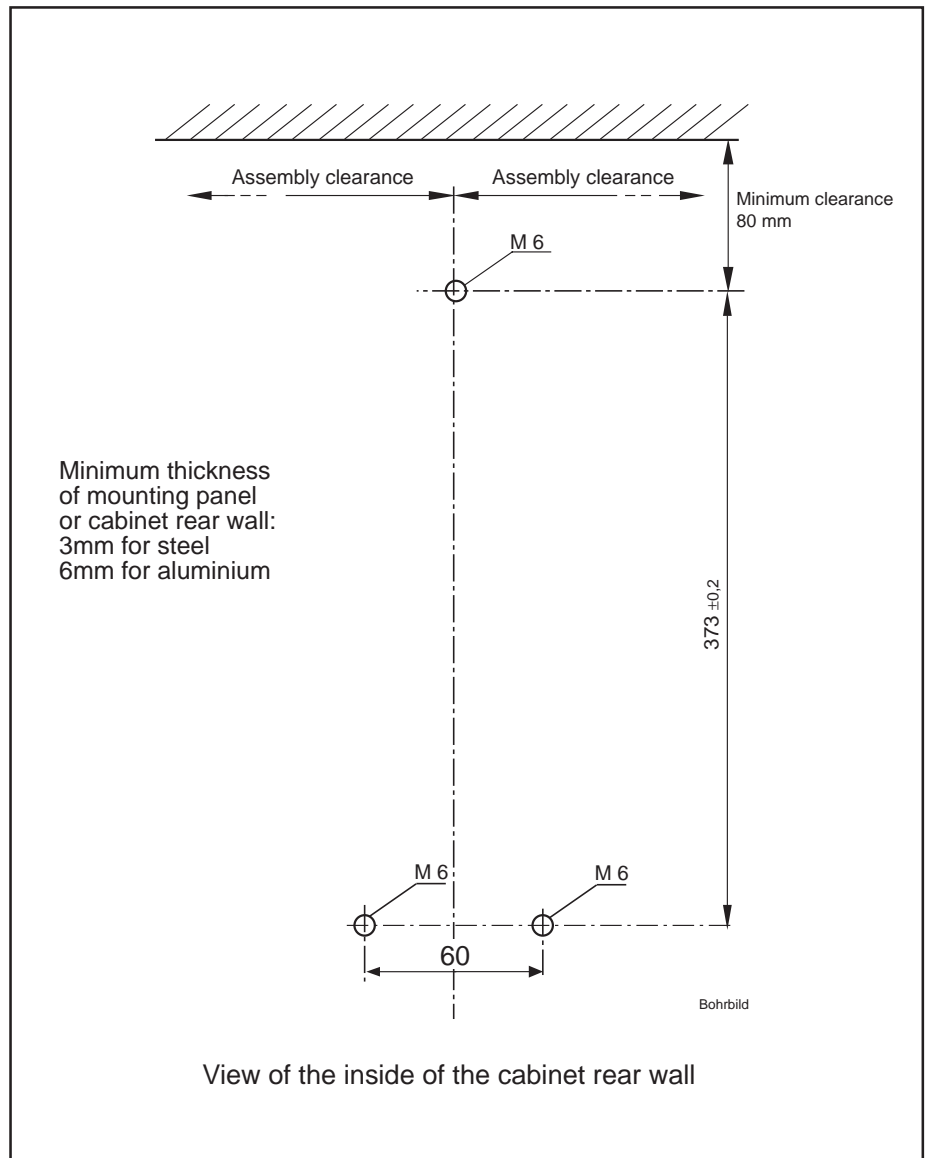
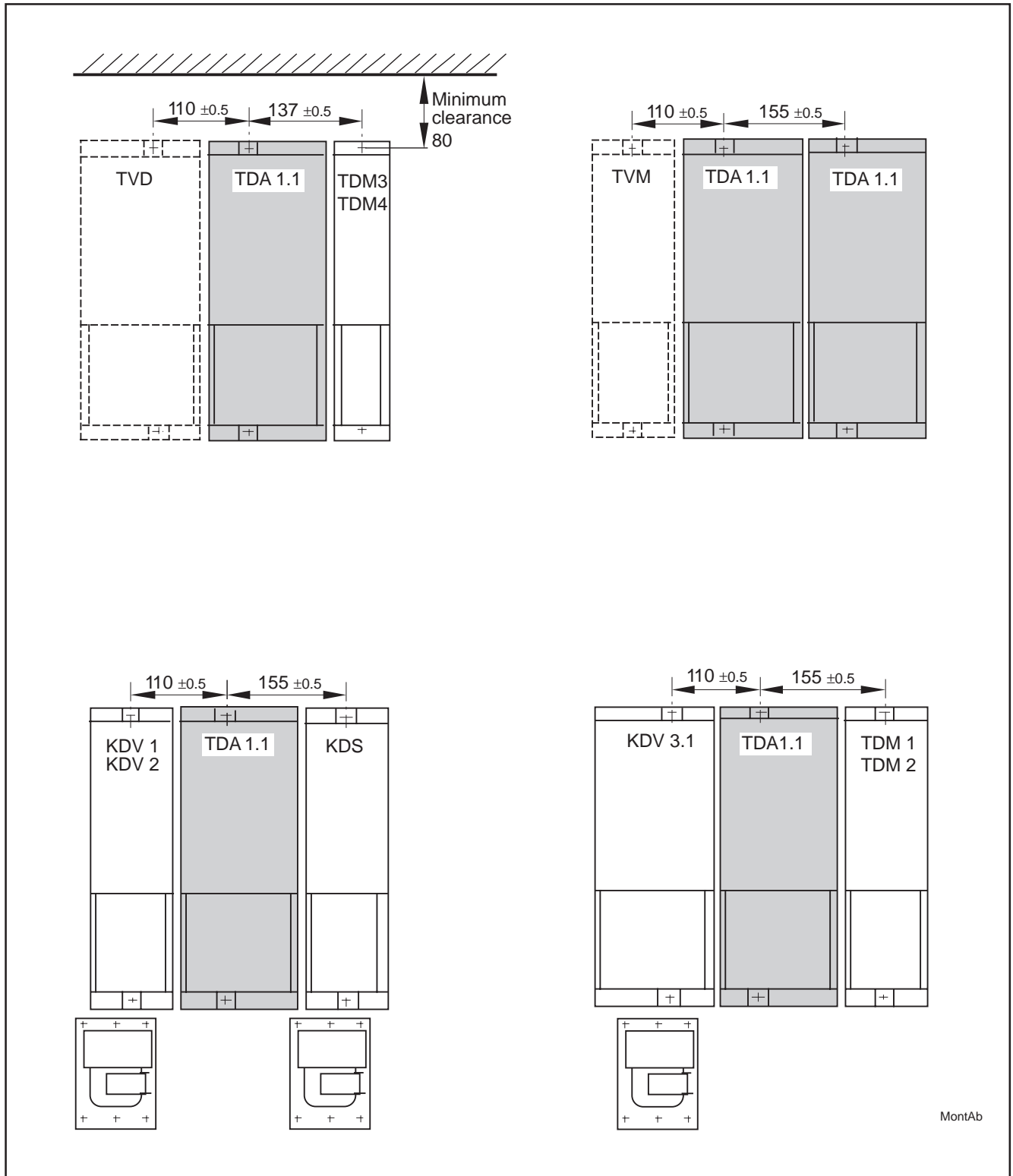

Fig. 9: Drilling pattern for the cabinet rear wall (for assembly clearance, see also Fig. 10)



MontAb

Fig. 10: Assembly clearance; distances between adjacent units in the drive equipment package and top clearance

2.3. Thermal data

When in operation the controller TDA 1 dissipates heat through the air vents in its housing to the air inside the control cabinet.

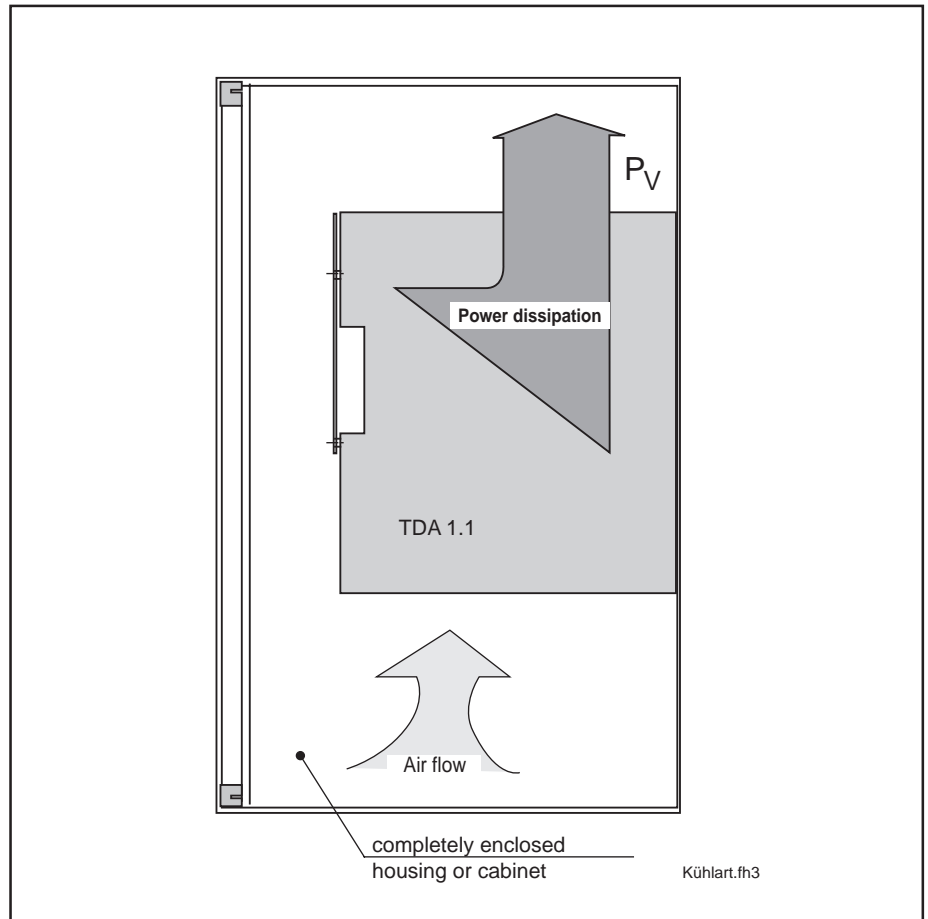

Fig. 11: Cooling principle of the controller TDA 1

The power dissipated by the TDA 1 is dependent on the load. In terms of dimensioning the cabinet or the air cooling system, it is however, sufficient to know the power dissipation related to the continuous power rating of the main spindle motor used.

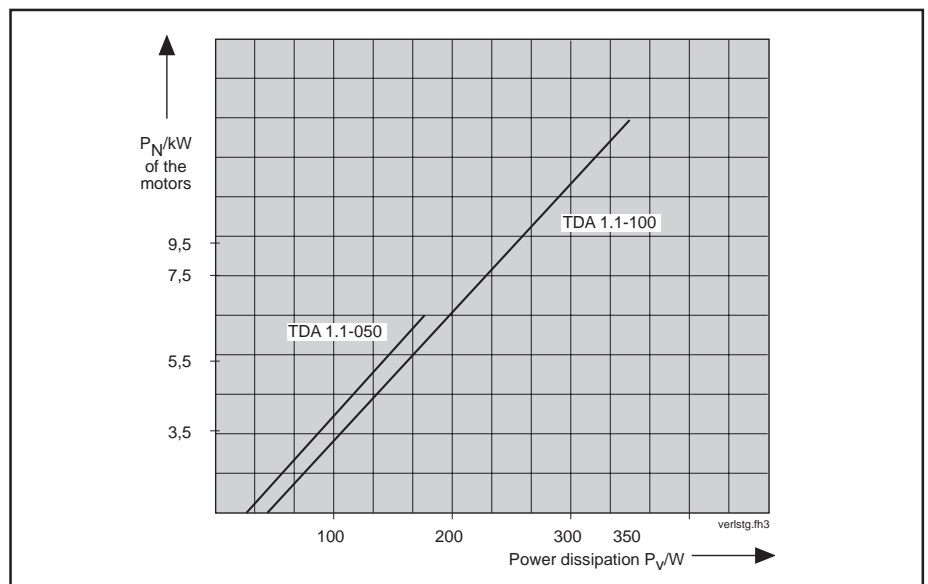

Fig. 12: Power dissipation of the TDA 1

2.3.1. Notes on the use of cooling power systems in control cabinets

The controller TDA 1 can only perform at full drive ratings up to an ambient temperature of 45°C . In order to keep within this environmental limit, it may be necessary to install a system to cool the air inside the control cabinet.

Improperly mounted cooling systems will expose installed controllers to the risk of moisture condensation and the effects of condensation water!

Moisture condensation risk

Hot humid air penetrating the control cabinet will condense on the controller while cooling!

Condensation water risk

If the cooler is wrongly located in the control cabinet, the condensation water inherent to cooling systems may drip down onto the installed controllers or be sprayed into them along with the flow of cooling air.

Proper mounting of cooling systems

Avoidance of moisture condensation

- When using cooling systems, select only well sealed control cabinets which will prevent any moisture condensing out of hot humid air penetrating from the outside.
- If the control cabinet has to be operated with its doors open (on commissioning or during repairs, etc.), precautions must be taken to ensure that the controllers will never be cooler than the air in the cabinet once the doors have been shut again, as moisture will otherwise condense on them. The cooling system must therefore always be in operation even while the machine is shut down to keep the temperature of the air in the control cabinet and that of the installed equipment at the same level.
- Cooling systems with fixed temperature settings must be set to 40 °C, not lower!
- Cooling systems with temperature controllers must be set such that the temperature of the air inside the control cabinet is less than 2°C below that of the air outside the cabinet. Set the temperature limit to 40°C!

Avoidance of water drips or spray

- Always arrange cooling systems such that condensation water cannot drip down onto installed controllers. If cooling systems are to be mounted on top of control cabinets, the cabinet must be specially designed (see Fig. 12.1)!
- Design the control cabinet such that the fan of the cooling system will not spray condensation water which has collected while the system is shut down onto the controllers (see Fig. 12.2)!

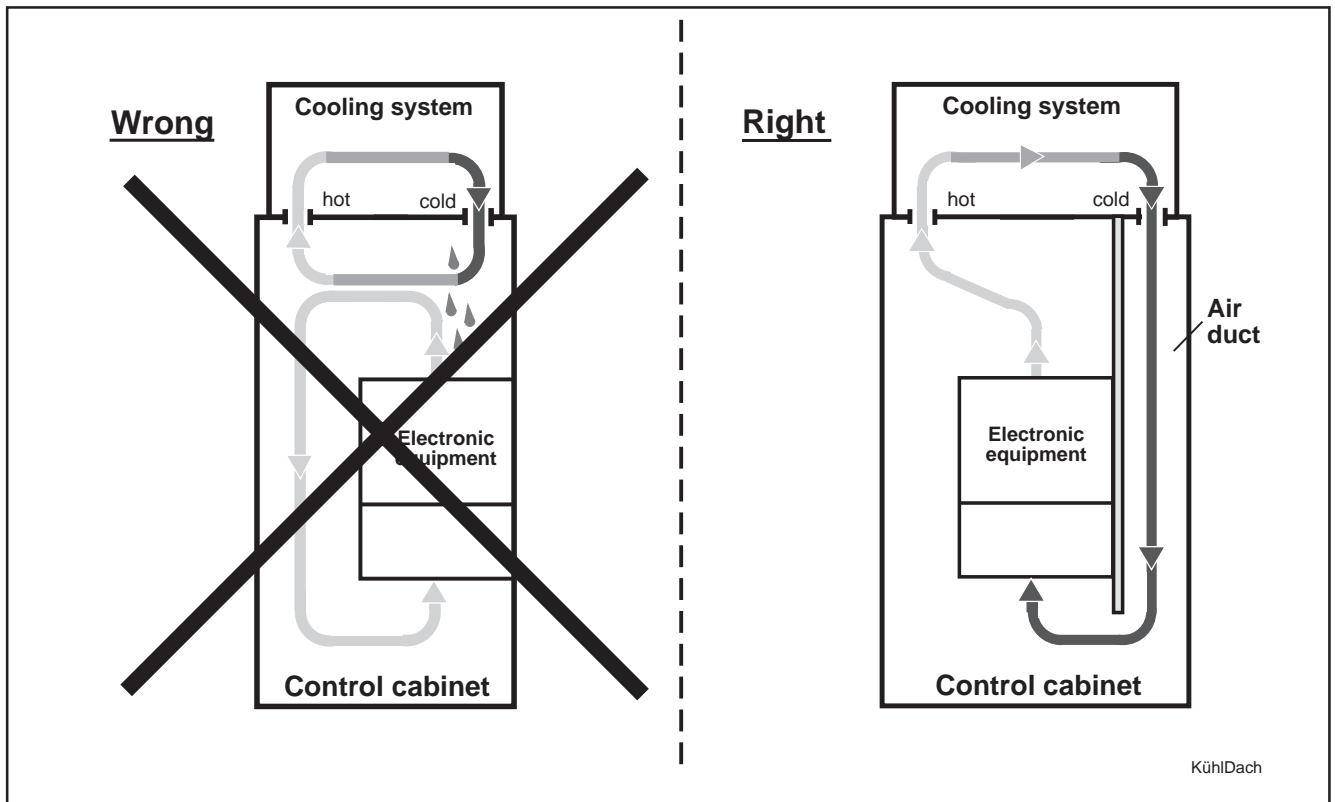

Fig. 12.1: Arrangement of cooling system on top of the control cabinet

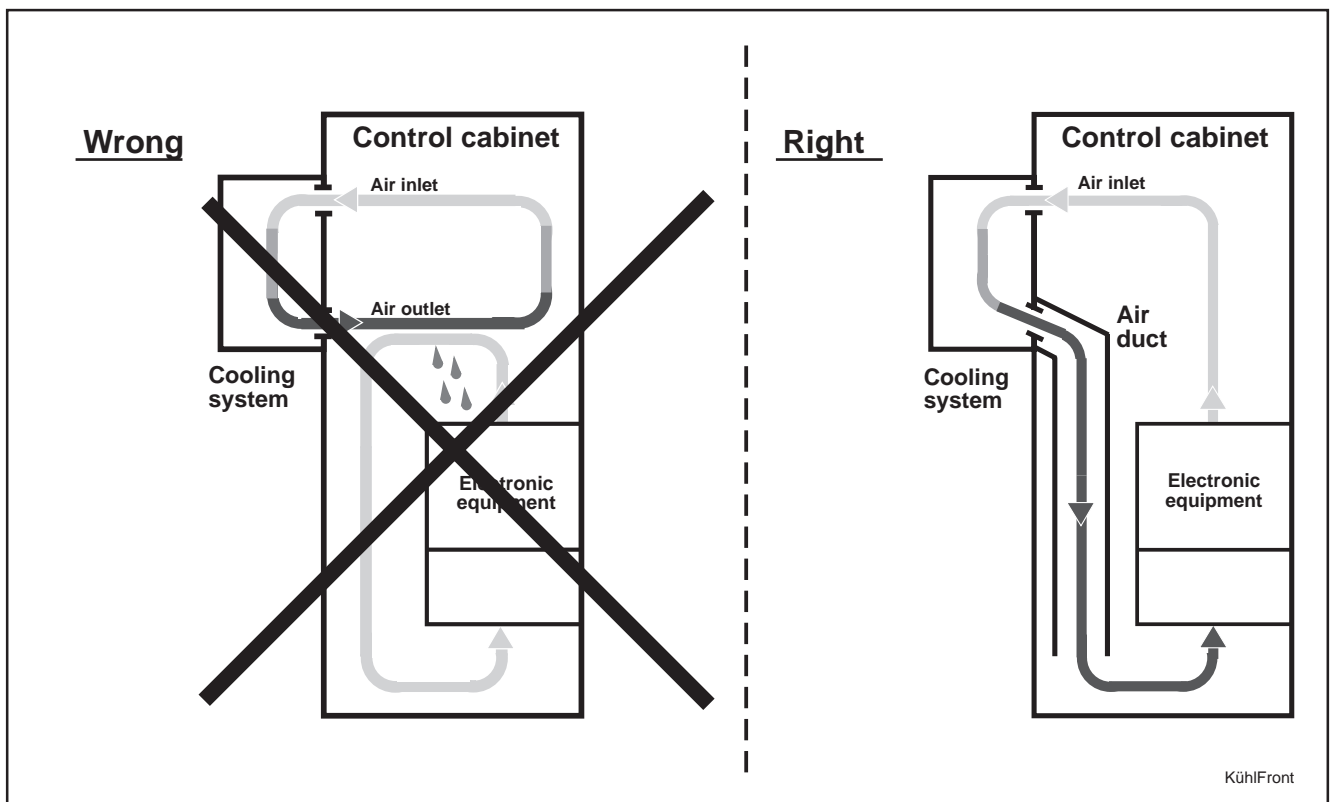

Fig. 12.2: Arrangement of cooling system on the front face of the control cabinet



**Precautions must be taken to prevent condensation water from the cooling system dripping onto installed controllers!
Ensure that the cooling temperature setting is always correct!**

2.4. Electrical data

Connection diagram
(schematic)

The connection diagram shown in Fig. 13 is of a schematic nature. It serves as a check list for all electrical connections required to operate a main spindle drive.

The electrical connections of INDRAMAT main spindle drives have been standardised in order to restrict the variety of cable types.

All INDRAMAT main spindle drives are equipped with three categories of electrical connections:

- feedback and NC connections
- power connections
- connections specific to the controller

Connection diagrams for
feedback, NC and power
connections

Irrespective of the type of main spindle unit, the feedback, NC and power connections are all configured with the same plug-in connector or terminal assignments. The connection diagrams are therefore contained in the documentation "Electrical connections of main spindle drives; Project planning" (No. 209-0042-4111). This documentation is indispensable when preparing the machine circuit diagram!

Connections specific
to the controller

In addition to the connections mentioned above, certain specific connections are required to integrate the controller TDA 1 into the drive package (see Fig. 16 and 17). These connections are shown in the schematic connection diagram (Fig. 13).

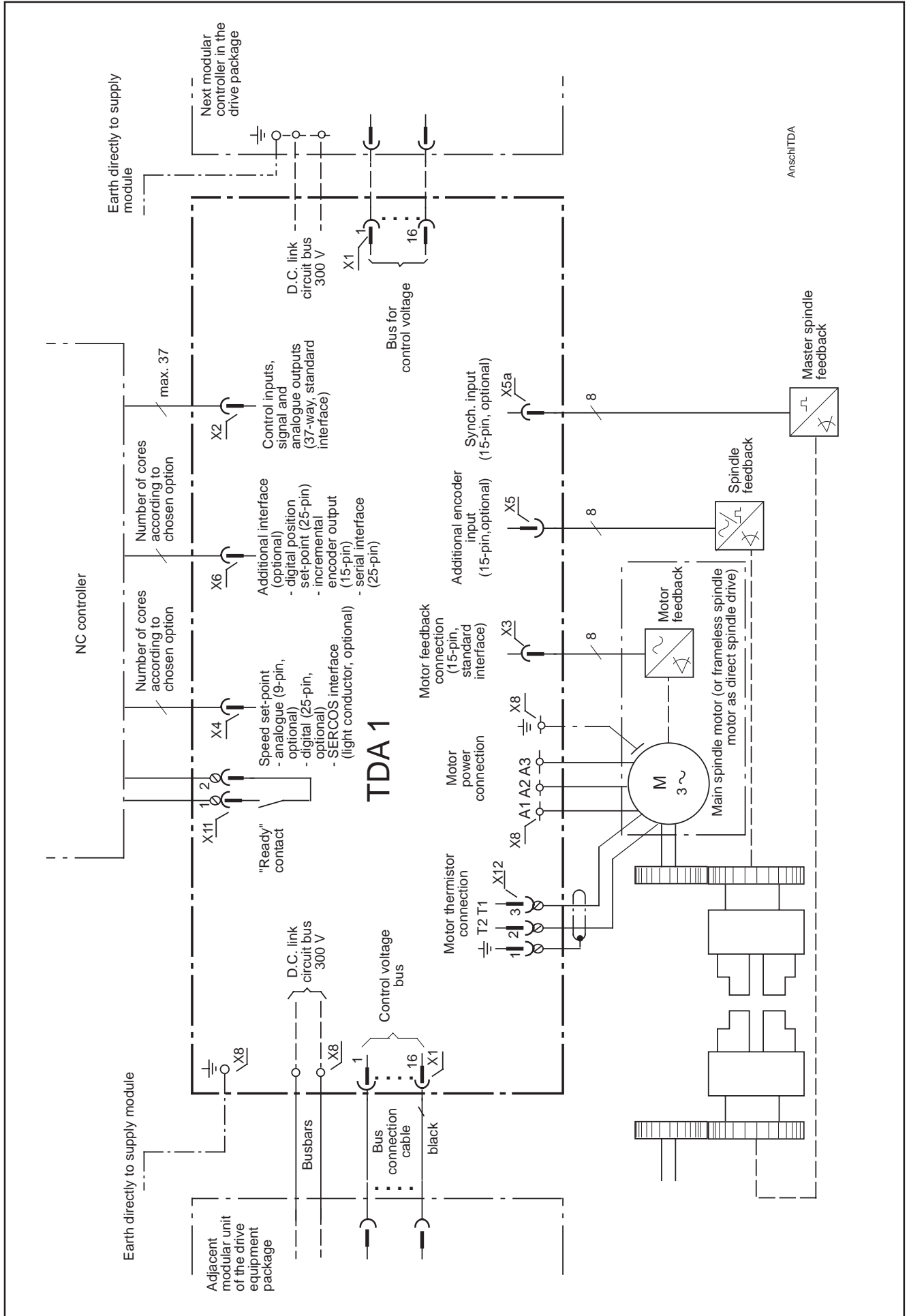

Fig. 13: Schematic connection diagram TDA 1

Feedback and NC connections

Irrespective of the type of main spindle controller, the interfaces of all feedback and NC connections are identical as to terminal assignment and designation. They are contained both in the documentation "Electrical connections of main spindle drives" (No. 209-0042-4111) and in the documentation "AC main spindle drives with controlled asynchronous motor or frameless spindle motor; Applications Manual" (No. 209-0041-4109).

The functions and signal levels related to these interfaces are also identical irrespective of the main spindle controller. They are described in the latter documentation.

The necessary electrical connections are dependent on
– the selected function options of the controller.

Fig. 14 illustrates the (standard) interfaces to be found on any main spindle controller, listed according to the index code for the respective connection diagram. Fig. 15 shows the assignment of the function options of the controller to the respective connection diagram, according to the listed index code.

The connection diagrams for feedback and NC connection can now be found by searching for the index code (last column of Fig. 14 and 15) in the documentation "Electrical connection of main spindle drives; Project Planning", whose list of keywords contains these index codes.

Type code: TDA 1-●●●-●●●●●●●●●●

see Doc.
"Elec. connections of
main spindle drives"

Standard interface	Designation	Connections terminals	Index code
Interface to NC	Control inputs, signal and analogue outputs	X2, 37-pin	IKS 610
Interface for feedback	Motor feedback connection	X3, 15-pin	IKS 315

Fig. 14. Assignment by index code of standard interfaces to connection diagram

Type code: TDA 1-●●●-●●●-□□□

Function options
Circuit diagram
see Doc.
"Elec. connections of
main spindle drives"

Function options	Coding	Designation	Connection terminals	Index code
□□□ Speed command value input (type code field 6)	A	analogue	X4, 9-pin	IKS 613
	D	digital 16 bit parallel	X4, 25-pin	IKS 612
	L	SERCOS interface	X4, light-wave conductor	IKO
□□□ Additional encoder input (type code field 7)	O	without additional encoder input		
	P Y	with additional encoder input	for high-resolution INDRAMAT encoder (~) X5 15-pin for incremental encoder (J L)	IKS 312 IKS 327
		... and synchronisation input	X5a, 15-pin (J L)	master spindle feedback
□□□ Additional interface (type code field 8)	O	none		
	D	digital position command value	X6, 25-pin	IKS 614
	I	incremental encoder output	X6, 15-pin	IKS 620
	S	serial interface RS 232 C	X6, 25-pin	IKS 015

Fig. 15: Assignment by index code of controller function options to the electrical connections on the unit and to connection diagrams

Controller-specific connections

For different locations of the modular main spindle controller within the drive package, there are matching specific electrical connection cables. These are contained in the electrical connection accessories.

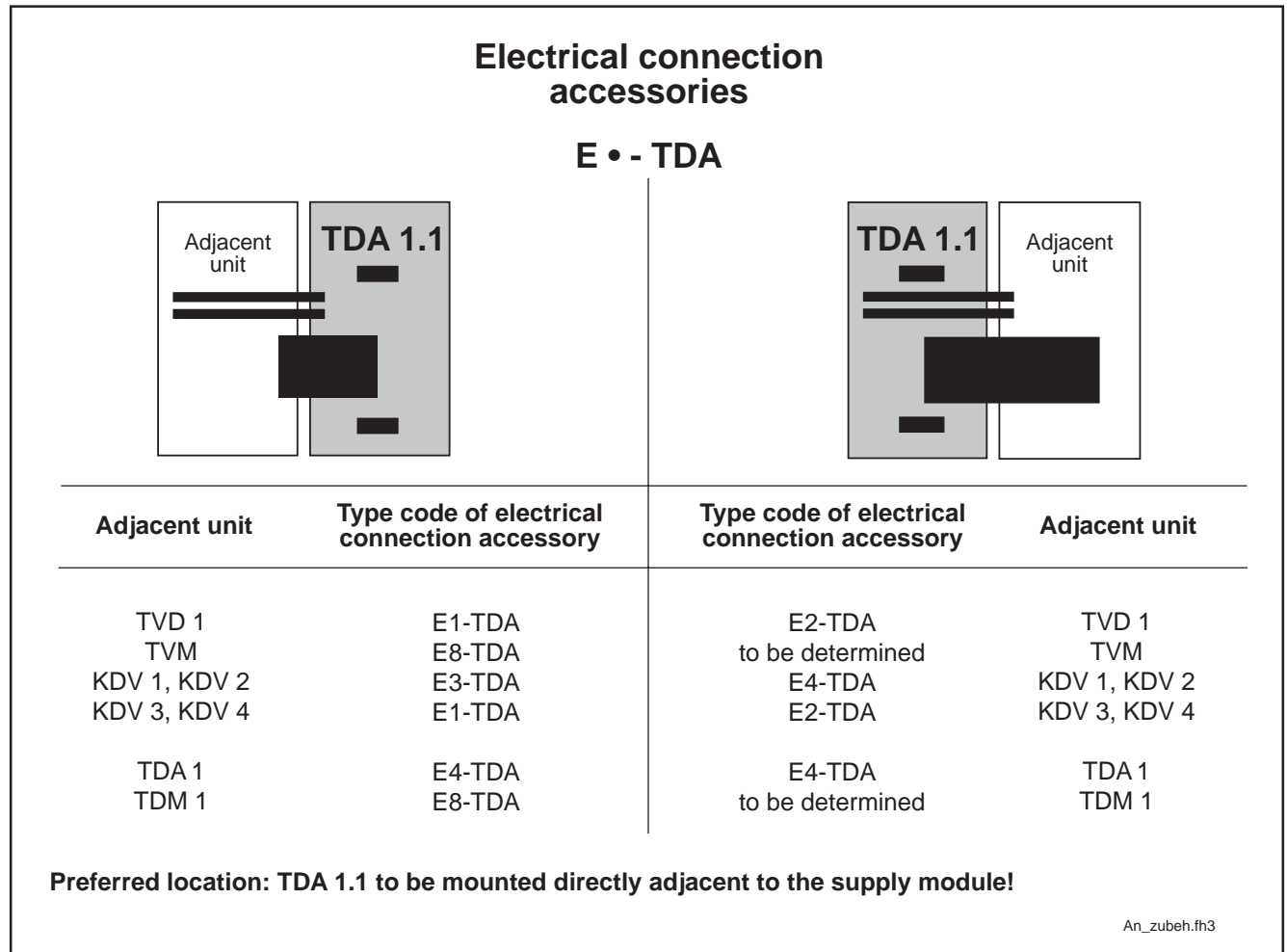

Fig. 16: Electrical connection accessories for different locations of the modular controller within the drive package

The electrical connection accessories comprise the following parts:

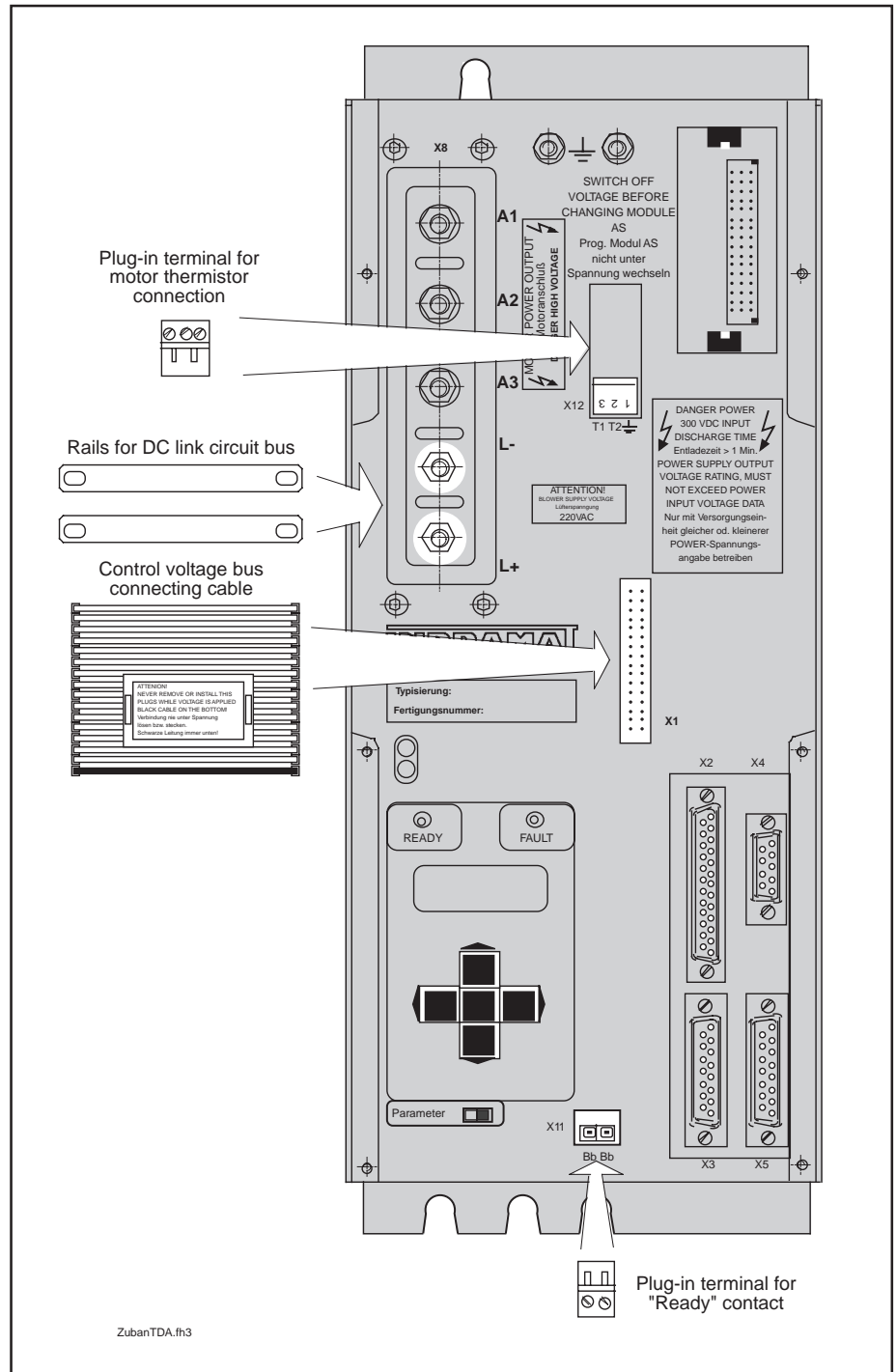

Fig. 17: Electrical connection accessories E...TDA

The connection diagram for the specific controller connections corresponding to its location within the drive package is indicated in Fig. 15.



The controllers of a drive package must be separately earthed to the supply module! Minimum conductor cross-section of the earthing cable is 10 mm²!

Power connections

The connection diagrams and conductor cross-sections for power cables can be found by searching for the index code (last column of Fig. 18) in the documentation "Electrical connection of main spindle drives; Project Planning", whose list of keywords contains these index codes.

Conductor cross-sections depend on the continuous current rating of motors in drives permitting intermittent, brief operation at motor overload current.

Drive combinations: TDA 1 - ●●● - - ●●● with ...	
... main spindle motor	Index code (see Doc. "Electrical connections of main spindle drives")
2AD 100B 100C 100D 2AD 101C 101D	2AD 100 with KDA/TDA
2AD 132 B 132 C 132 D	2AD 132 with KDA/TDA
... frameless spindle motor	
1MB 160 E B D F	1 MB with KDA/TDA
1MB 200 D	1MB with KDA/TDA
1MB 240 B D F H	1MB with KDA/TDA
1MB 310 B	1MB with KDA/TDA

Fig. 18: Assignment by index code of the main spindle motors and frameless spindle motors to the relevant connection diagram

For motor/controller combinations where the continuous effective current of the controller is lower than the rated motor current, the unit can be sized according to the lower value!

For continuous effective currents of controllers with different current ratings, see Fig. 19, "Technical data TDA 1".

2.5. Overview of technical data

Designation	Symbol	Unit	TDA 1-050 - 3 - - - ●●●●	TDA 1-100 - 3 - - - ●●●●
Cooling principle			with air inside control cabinet	
Link circuit rated voltage	U(DC)	(V)	300	300
Current rating	I(typ.)	(A)	50	100
Continuous effective current	I(cont)	(A)	35	70
Power consumption (bus for control voltage)				
+ 24V load voltage	I(+UL)	(A)	1.2	1.4
± 15V test voltage	I(±UM)	(mA)	160	160
Weights				
Weight of controller	m	(kg)	10.5	10.5
Operating conditions				
permissible ambient temperature range at nominal ratings	(° Celsius)		+5° to +45°	
max. permissible ambient temperature at reduced ratings	(° Celsius)		+55°	
storage and transportation temperature	(° Celsius)		-30° to +85°	
max. altitude without limitation of nominal ratings			1000 meters above sea level	
permissible humidity of air as per humidity class			F as per DIN 40 040	
protection type			IP 10 as per DIN 40 050	
			aus ENA7A-KDA3/TechnDaten/209-0042-4105-03	

Fig. 19: TDA 1 - technical data

2.6. Type codes

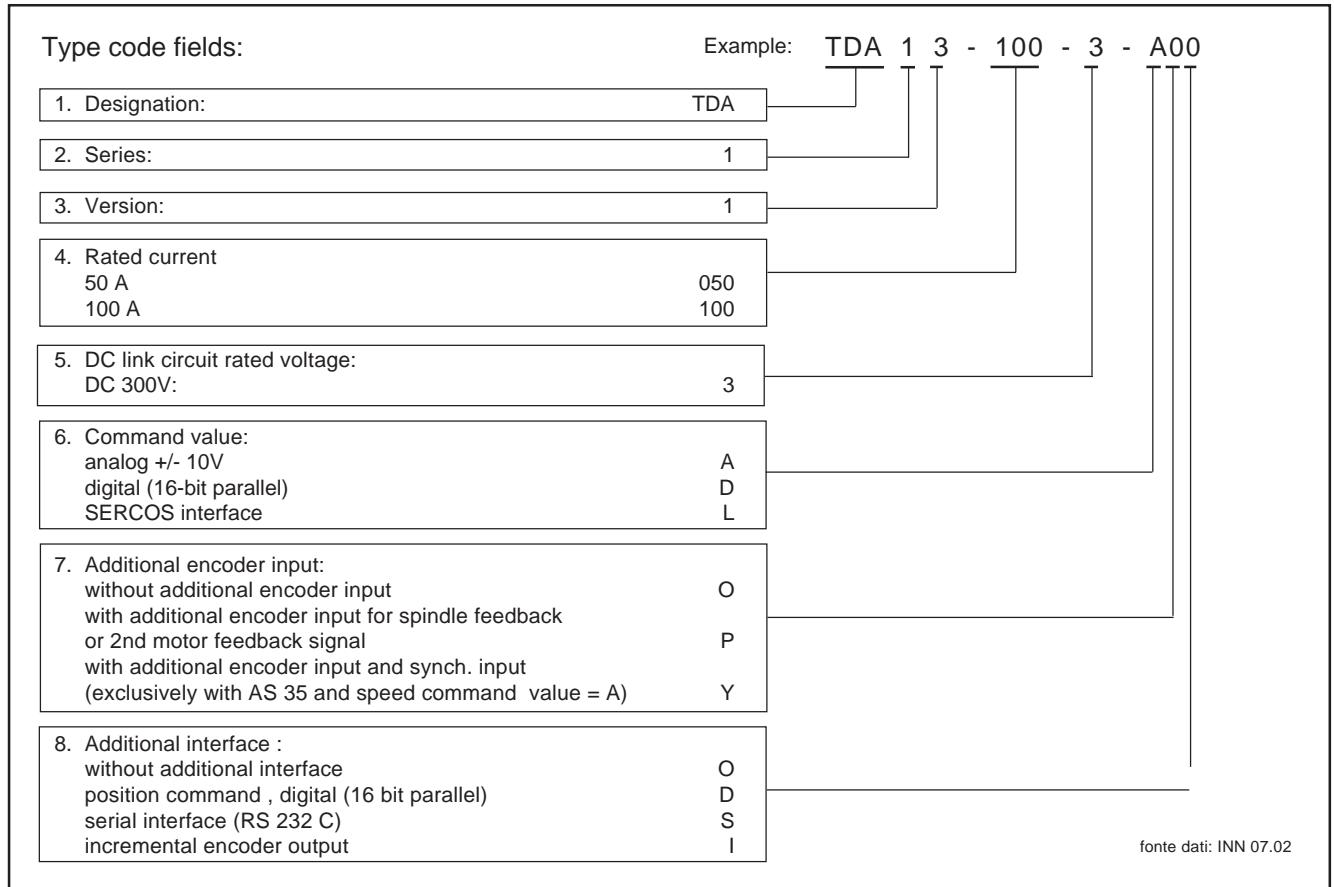

Fig. 20: TDA 1 - type codes

3. Programming Module AS

The programming module AS plugged into the controller serves to match the controller to the main spindle motor and to create the operating characteristic for the main spindle drive.

INDRAMAT supplies the appropriate programming module AS (standard version according to selection data) for each main spindle drive in the product range.

INDRAMAT main spindle drives are microprocessor-controlled.

Rapid start-up of the drive

Due to its associated programming module AS, the main spindle drive is immediately ready for start-up without any further matching operation being required. The only pre-requisites are that the drive must have been properly connected up (see section 2.4) and properly commissioned (see section 9).

INDRAMAT main spindle drives can be matched by means of parameters to the specific machine configuration and the functional requirements of the application.

Benefit in the event of unit replacement

The programming module AS carries the operating software and the parameters. Should a unit need to be replaced, the new controller does not require to be matched, since it is immediately compatible with the motor and the machine once the existing and already matched programming module is plugged in.

Duplication

Matched programming modules can be very easily duplicated for use on other identical machines. This is done using the parameter duplicating adapter or by transfer via a serial interface and a facility with a memory (PC or similar).

Parameters

The operating software comprises two groups of parameters:

- those specific to the drive, and
- those specific to the application

Drive parameters govern the operating characteristics of the drive. To create the operating characteristics of the drives, INDRAMAT calculates and determines the relevant parameter values.

Application parameters are used to activate the functions of the main spindle drive or to modify them to suit the application, and thus to match the drive to the machine.

Entering and editing of parameter values

The procedure for entering and editing parameter values is identical for all INDRAMAT main spindle controllers. This is done using the keypad on the control panel of the controller.

For more details, see the section "Operating the controllers" of the documentation "A.C. main spindle drives with controlled asynchronous motor or frameless spindle motor; Applications Manual" (No. 209-0041-4109).

3.1. AS programming module versions

The application-related parameter values calculated by INDRAMAT are contained in the associated programming module AS.

Standard

Application-related parameters are assigned standard values. The machine-related and application-dependent parameters are entered in the module on site.

The documentation and management of these machine- and application-related parameters is the responsibility of the customer.

Customised (for mass-produced machines)

If a programming module which has been assigned machine- and application-related parameter values is to be documented, managed and supplied by INDRAMAT, a customised programming module is created. This is done on customer request after consultation with INDRAMAT and is subject to an **extra charge**.

3.2. AS programming module compatibility

The latest state of the art (updating of the programming module AS) for operation of the drive is supplied without any change being made to the ordering code (type designation) of the programming module. Updated programming modules are compatible with programming modules already in the field.

Updating of the programming module AS

The drive is guaranteed always to operate to the latest state of the art although no change has been made to the ordering code of the programming module.

This means:

- debugging of software errors
- extension of the scope of functions without any impairment to existing functions
- improved parameter values for the motor/controller combination

3.3. Rating plate

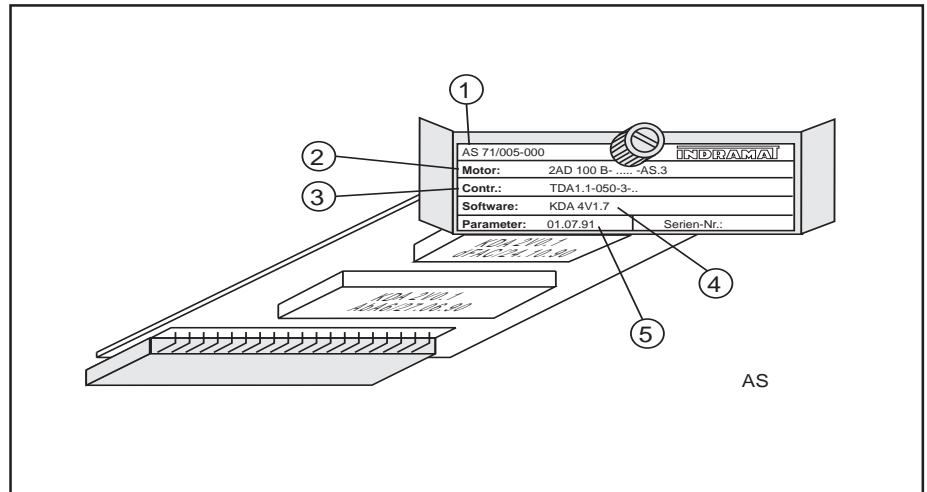

Fig. 21: Programming module with ratings

① Type designation

In the standard version, programming modules carry the suffix -000. Customised programming modules end with a personalised number determined by INDRAMAT.

② Motor ratings

③ Controller ratings

The ratings given on the programming module for motor and controller must coincide with those of the installed motor and controller, otherwise there is a risk of damage to the equipment!

④ Software designation

The alphanumerical code, including the letter "V", denotes the software type and version, the following digits represent the serial number of the software update.

⑤ Date of parameter selection

This records the technical status of the parameter values, including the parameter values as recorded at INDRAMAT.

3.4. Type codes

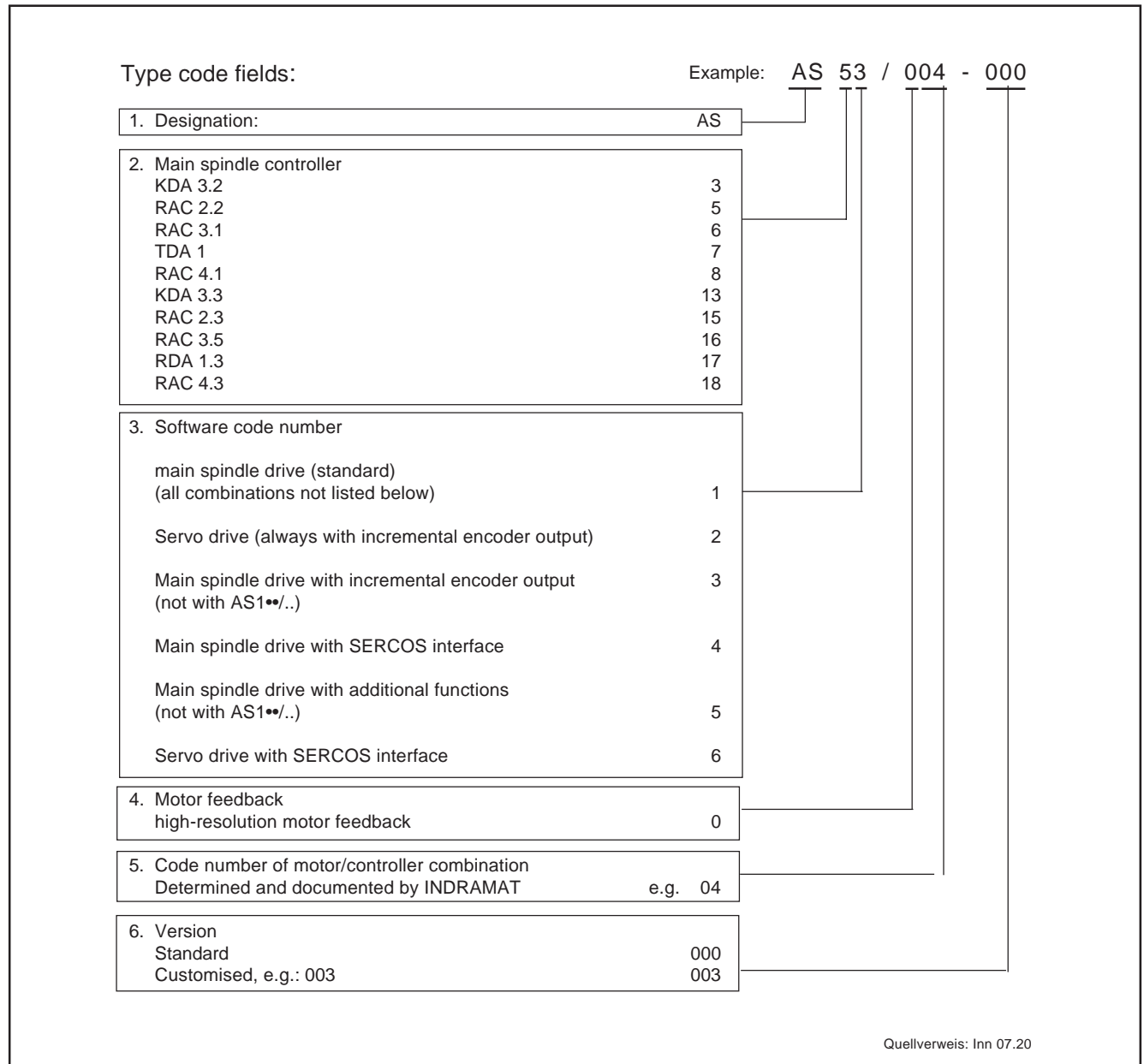

Fig. 22 : Type code of programming module AS

4. Condition as delivered

The equipment is packed in cardboard boxes on shipment. For single or mixed orders (several different units) the units are packed in disposable packaging material. Accessories are packed in a separate cardboard box. All single boxes are stacked together in a larger transport container (cardboard box or pallet) for delivery.

If several identical units are to be supplied, returnable packaging may be used.

The transport container carries an envelope containing 2 delivery notes. No further shipment documents are provided unless specifically requested in advance.

To avoid damaging the equipment on unpacking, first slit open the glue points!

5. Equipment identification

The transport container carries a delivery note in duplicate. The contents listed for the shipment may be distributed amongst several packages (transport containers). This is stated on the delivery note or the waybill.

The delivery note lists the equipment according to designation and ordering code.

For mixed orders, the transport container holds separately packed controllers and their accessories, for multiple orders of identical units the accessories can be packed in a separate container.

Main spindle drive TDA 1

The packaging for the TDA 1 is provided with a barcode sticker. This serves to identify the contents as to the version and the order handling data.

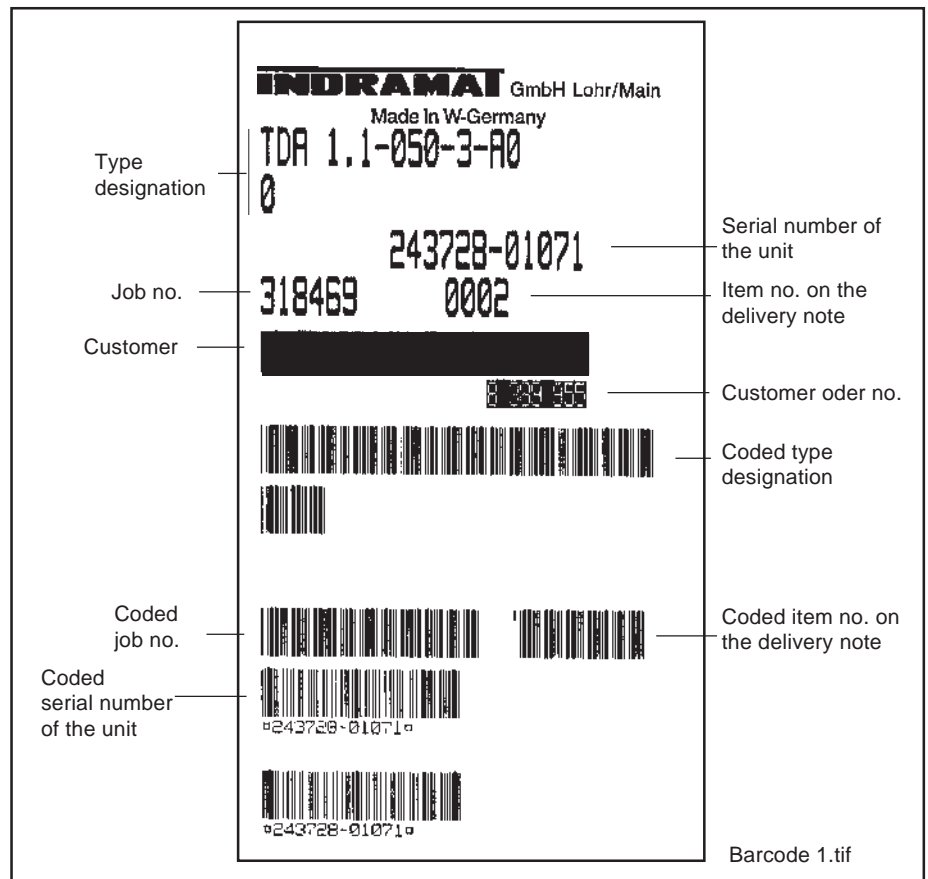

Fig. 23: Barcode sticker on the package of a TDA (example)

If there are more than one identical units in a package, the serial numbers of all the packed units are given on the barcode sticker (applies to reusable packaging material only)

The TDA 1 itself is provided with a sticker on the side, which carries all necessary data for unit replacement. This corresponds to the barcode sticker and also carries the date of shipment.

The rating plate is fixed to the front panel of the TDA. It remains visible even after the TDA has been installed in the drive equipment package (as opposed to the sticker on its side!)

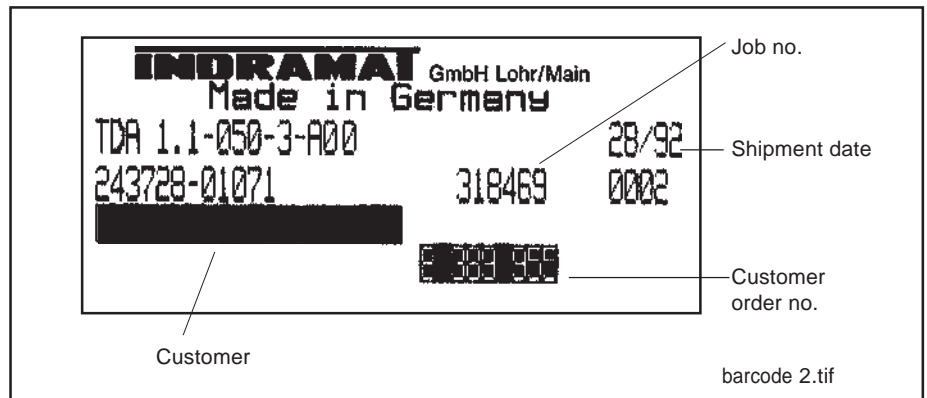

Fig. 24: Service sticker (located on the side of the unit, example)

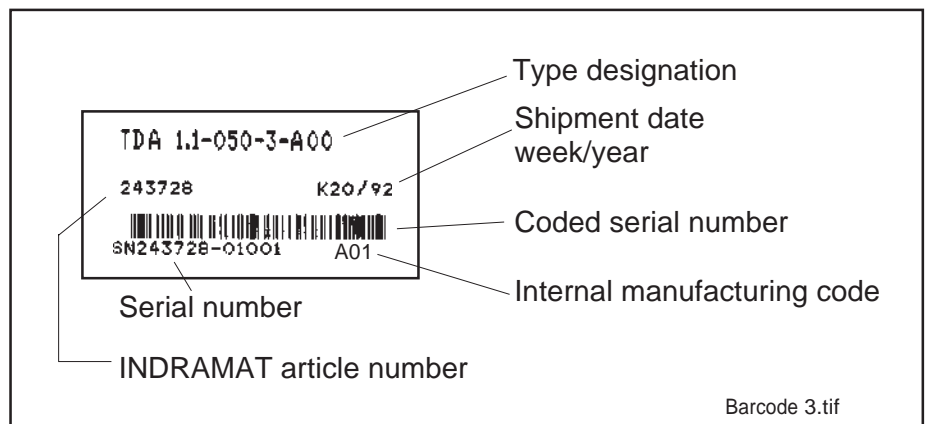

Fig. 25: Rating plate TDA 1 (located on the front panel, example)

Programming module AS

Programming modules are always packed singly in bags and then in cardboard boxes. The bag protects the programming module AS from electrostatic charges. Touching the printed circuit board with fingers can cause damage! The programming module number is stated on the outside of the box.

Along with the programming module, the bag also contains the parameter list. This gives all data relating to the programming module, and documents the parameter values as set on delivery.

If, for instance, the parameter values should be accidentally erased during commissioning, the original values can be entered by hand using the parameter list. This parameter list must be stored in the machine file!

The programming module carries a rating plate on the front (see Fig. 24).

Accessories

Electrical accessories are packed in bags and marked with the ordering code (accessories, see Fig. 17).

6. Storage and transportation

Always store controllers in a dry, dust, and impact-free place with an ambient temperature range of -30 to +85°C.

If strong vibrations are to be expected during transportation, the equipment must be supported by a vibration damping substrate!

Transportation markings on the packaging:



Fig. 26: Safety instructions for transportation

7. Assembly

Installing the modular main spindle controller in the control cabinet

The mounting plate in the control cabinet or the rear wall of the cabinet must have three M6 tapped holes according to Section 2.2, Fig. 9. Take care to observe the correct mounting clearance to the next unit! The units must always be mounted in vertical position!

First screw in three socket head cap screws M6 - DIN 912 (Allen screws) far enough into the holes so that they cannot fall out.

Tip the controller forwards and let it first engage with the lower two Allen screws.

Then push the controller back against the rear wall, raising it slightly until the upper mounting hole engages with the top Allen screw.

Now tighten all screws!

The controller mounting is illustrated in perspective in Fig. 27 (installation sketch).



An Allen screw driver with a shaft length of more than 400 mm is a great help when mounting the controller!

The controller should already be fitted with the programming module AS 7 •/•••–••• on installation. This is plugged into the upper right corner of the TDA 1 and secured with a knurled screw!



Before commissioning the TDA 1, the programming module must be in place and securely held by a knurled screw.

7. Assembly

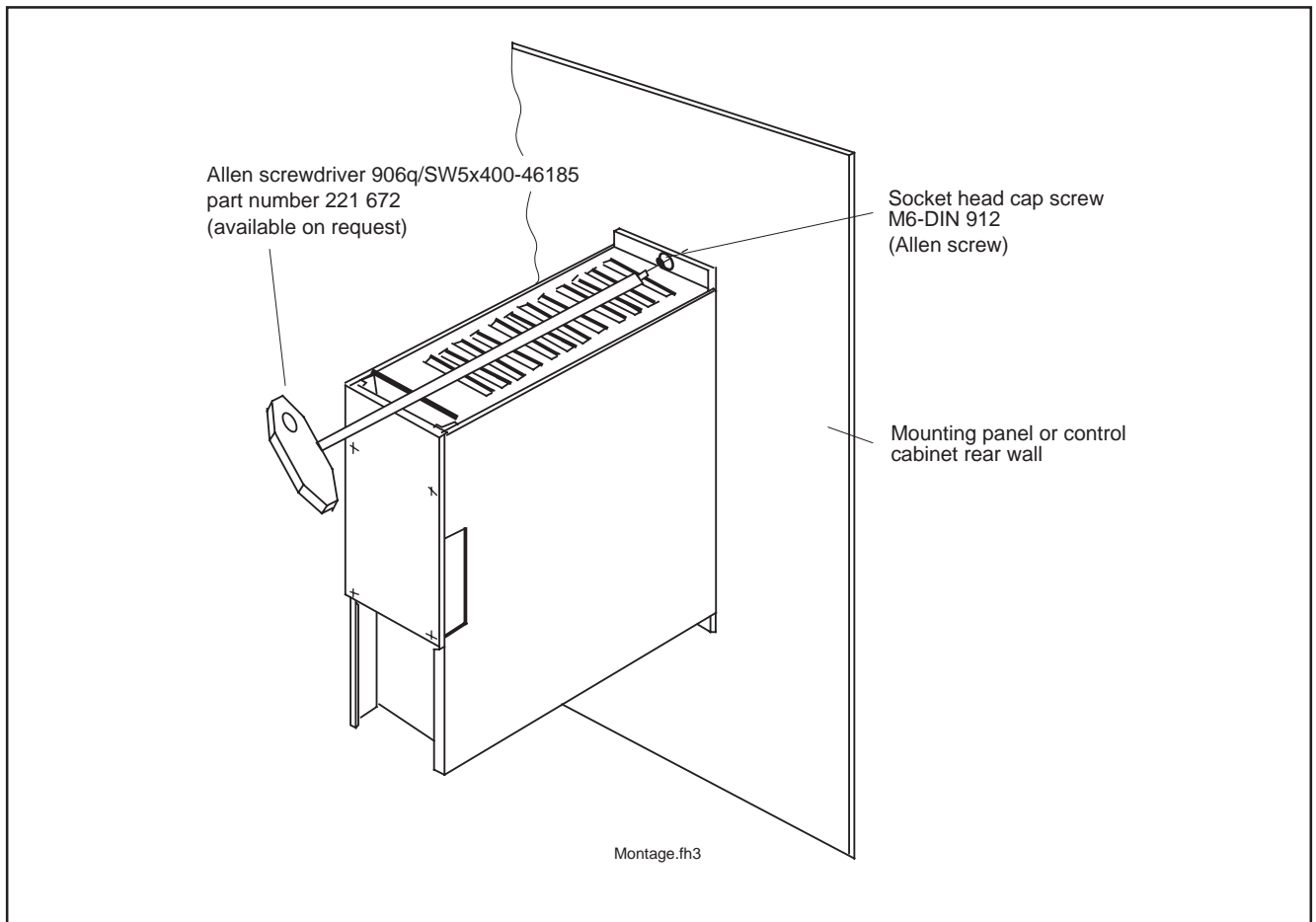

Fig. 27: Installation sketch

8. Installation notes

- The circuit diagram of the machine manufacturer must be adhered to!
- The machine circuit diagram must be based on the INDRAMAT circuit diagrams!
- The transparent protective cover on the front face of the unit must be screwed on during operation!
- Always disconnect power before removing the programming module AS. When the unit is in operation, the knurled screw must be tightened down!
- Observe the maximum tightening torque for the stud bolts. These may shear off if excessive force is applied!
- The D-type sub-miniature connectors must be firmly screwed down when the system is in operation!
- Twist the cores of the power cable!
- Plug the end connector of the control voltage bus (accessory for the supply module) into the last controller in the drive package!
- Earth the motor to the controller and the controller directly to the supply module!



If the controllers cannot be installed directly adjacent to one another, the conductors of the DC link circuit bus must be kept as short as possible! Special bus connecting cables for control voltages are available for this case!



If flexible cables are to be used for the DC bus (L+, L-) instead of busbars, then make sure that the cables are as short as possible, but always of equal length and stranded!



When measuring power in the DC bus circuit with additional test systems, make sure that there is the least amount of surface between L+ and L-! Possible star-shaped L+, L- cable routing!

9. Commissioning guidelines

The commissioning procedure is the same for all modular main spindle controllers (KDA 3.2, TDA 1). Because of this fact and due to the extensive scope of functions, it is only described once in the documentation "AC main spindle drives with controlled asynchronous motors or frameless spindle motors; Applications Manual" (No. 209-0041-4109) which is valid for all INDRAMAT main spindle drives.

10. Servicing notes

10.1. Fault diagnosis

The TDA 1 diagnoses drive faults via the display on the control panel. Should a fault occur, the drive will brake to a standstill, and the drive package will then cut the power. Fault diagnoses are the same for all different types of mains spindle controllers.

Therefore, the fault diagnoses and instructions on how to clear faults are described in the documentation "AC main spindle drives with controlled asynchronous motors or frameless spindle motors; Applications Manual" (No. 209-0041-4109), which is valid for all INDRAMAT main spindle drives.

10.2. Unit replacement

In order to guarantee a high degree of machine up-time, a defective TDA 1 will be replaced, the defective unit being sent back to INDRAMAT for repair.

Since the TDA 1 has been matched to the drive and the machine via the programming module AS, this programming module is transferred to the new unit replacing the old one. The drive equipped with a new TDA 1 now displays the same characteristics as the original drive.

If it becomes necessary to replace a unit, the procedure is as follows:

- Prior to any work on electrical equipment, open the master switch and secure it against reconnection. The drives must be at a standstill, otherwise voltage will appear on the motor cables when the motors rotate.
- Wait for the link circuit (L+, L-) to discharge (≥ 1 min), and check that the voltage level is under 50 V before beginning to work. If in doubt, short-circuit (Cu-conductor, $A \geq 6\text{mm}^2$)!
- Unscrew the protective cover (transparent plate) of the TDA 1 and the adjacent units in the drive package.
- Remove the rails of the link circuit bus and disengage all other connections.
- Loosen the Allen screws at the top and bottom of the housing and remove the TDA 1 from the drive package.



When mounting the new TDA 1, grip it at the top and bottom faces of the housing, otherwise you may risk injuring a hand.

- Hang the new TDA 1 on the screws and tighten them down.



Always disconnect the power supply before removing or plugging in the programming module! When the TDA 1 is in operation, the mounting screw on the programming module must always be tight!

- Remove the programming module from the defective TDA 1 and insert it into the new TDA 1. Tighten down the knurled screw.
- Connect up the new TDA 1 according to the machine circuit diagram.
- Screw on the protective transparent plate
- Re-start the machine (see documentation "AC main spindle drives with controlled asynchronous motor or frameless spindle motor; Applications Manual" No. 209-0041-4109, Section on commissioning).

11. Index**A**

Additional encoder input 12, 23
Additional interface 12, 23
Altitude, maximum 15
Altitude-related limitation of drive ratings 15
Ambient temperature 14
Analogue output 12
Analogue speed command 12
Analogue speed command value 23
Assembly 39
Assignment of motors to connection diagram 28

B

Busbars for DC link circuit 27

C

Commissioning guidelines 42
Condition as delivered 35
Connection diagram 23
Control cabinet design 14
Control inputs 23
Control panel 12
Control voltage bus 23
Control voltage bus conn. cable 27
Control voltage bus, design. 11
Cooling system 19

D

D-type subminiature connector 16
DC link circuit bus, 300V 23
Digital position command 23
Digital position command, design. 11
Dimensions 16
Drive package 10, 23

E

E•TDA 26
Earth connection 11
Earthing bolt 16
Elec. conn. access. parts 27
Electrical connection accessories 13, 26
Electrical connection accessories for different Io 26
Electrical data 23
Electrical protection 15
Entering and editing of parameter values 31
Equipment identification 36

F

Fault diagnosis 43
Feedback and NC connections 24
Function options 25

I

Incremental encoder output 23
Incremental encoder output, design. 11
Inspection plate 16
Installation notes 41
Installing the modular main spindle controller 39
Interfaces, feedback 11
Interfaces, NC control unit 11

M

Main spindle drive components 13
Main spindle motor 13
Master spindle feedback 23
Maximum permissible humidity 15
Min. cross-section, earthing cable 27
Modular drive package 10
Motor, components 13
Motor, conn. diagram 23
Motor fan cable 13
Motor feedback 23
Motor feedback cable 13
Motor feedback connection 23
Motor feedback connection, design. 11
Motor power cable 13
Motor power connection 23
Motor thermis conn. plug-in terminal 27
Motor thermistor connection 23
Motor thermistor connection, design. 11

O

Operating conditions 14
Overview of technical data 29

P

Plug-in terminal 16
Plug-in terminal for motor thermistor conn. 27
Plug-in terminal for ready contact 27
Plug-in terminal strip 16
Position command, conn. dia. 23
Position command design. 11
Power connections 28
Power dissipation 19
Power/drive ratings 14
Programming Module AS 31
Programming module AS 22
Programming module, design. 11
Protective cover 16

R

Rating plate 33
Ready contact, conn. dia. 23
Ready contact, design. 11
Ready contact, plug-in terminal 27

S

Schematic connection diagram 23
Serial interface 23
Serial interface, design. 11
Signal outputs 23
Signal outputs, design. 11
Speed command, conn. dia. 23
Speed command, design. 11
Speed command value 12
Standard interface, conn. dia. 23
Standard interface, design. 11
Standard interfaces to connection diagram 25
Storage and transportation 38
Stud bolts 16
Synchronisation input, conn. dia. 23

Synchronization input, design. 11

T

TDA 1 - technical data 29

Terminal block for motor and DC link 11

Thermal data 19

Tightening torque for stud bolts 16

Type codes 30, 34

U

Unit replacement 43

W

Weight, TDA 1 controller 16

Summary of supplementary documentation

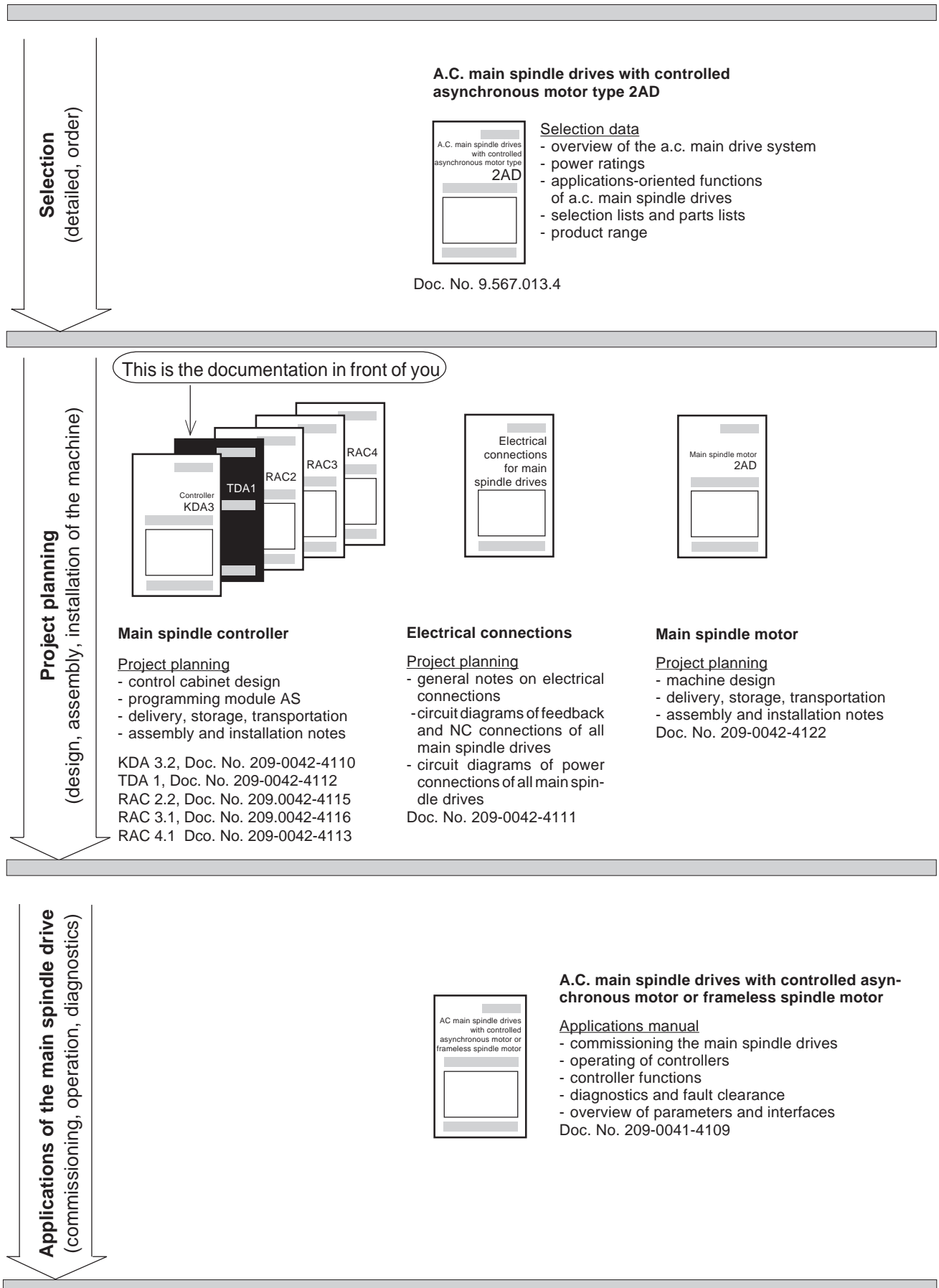
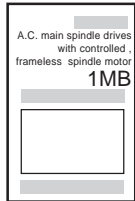

Fig. 29: Overview of supplementary documentation

A.C. main spindle drives with controlled, frameless spindle motor 1MB



- Selection data**
- overview of a.c. main drive system
 - power steps
 - applications-oriented functions of a.c. main spindle drives
 - selection lists and parts lists
 - product range

Doc. No. 9.567.012.4

A.C. main spindle drives with controlled asynchronous motor 2AD and switchable planetary gearbox type 2K

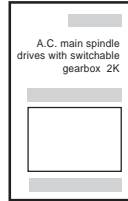

- Selection data**
- overview of a.c. main drive system
 - power steps
 - ordering instructions

Doc. No. 9.567.022.4

Selection
(detailed, order)

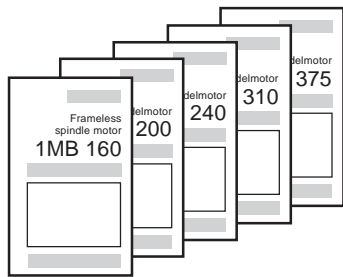

Frameless spindle motor

Project planning

- machine design
- connection to cooling system
- electrical and coolant connections
- delivery

1MB 160, Doc. No. 9.576.014.4
 1MB 200, Doc. No. 9.576.016.4
 1MB 240/241, Doc. No. 9.576.015.4
 1MB 310/312, Doc. No. 9.576.008.4
 1MB 375, Doc. No. 9.576.007.4

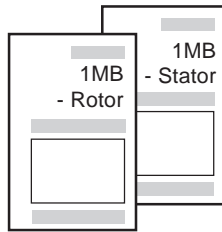

Assembly instructions

- delivery, handling, transportation
 - assembly
 - cooling system specifications
- Stator, Doc. No. 9.600.063.4
 Rotor, Doc. No. 9.600.062.4

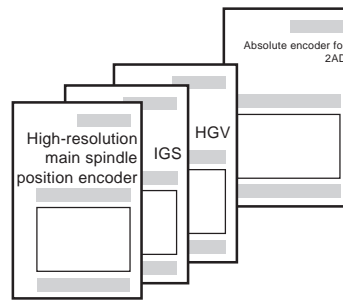

Current documentation

- High resolution main spindle position encoder
 - Doc. No. 9.552.247.4
- incremental encoder output IGS
 Doc. No. 9.568.015.4
- high-resolution encoder fan-out HG
 Doc. No. 9.568.010.4
- built-on absolute encoder for 2AD 132, 2AD 160, 2AD 180
 Doc. No. 9.568.020.4

Projekt planning
(design, assembly, installation of machine)

Applications of the main spindle drive
(commissioning, operation, diagnostics)

